

### 1 Description

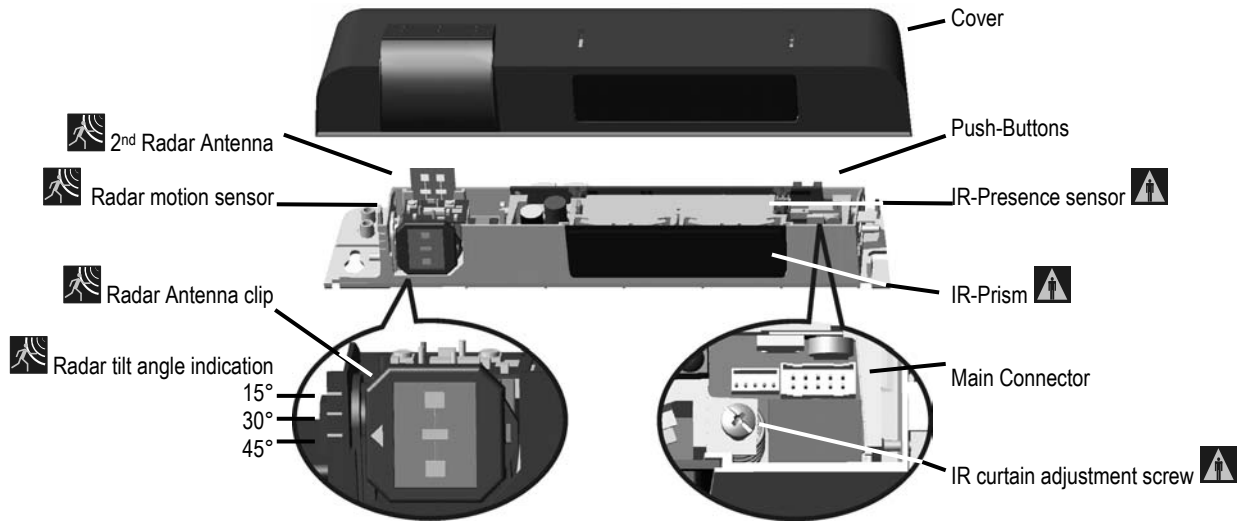

### 2 Symbols

LED turns on	LED flashing slowly	LED flashing quickly	Motion detection	Presence detection	Tip

**LED display during normal function**

	GREEN LED	Motion detection
	RED LED	Presence detection Short flash after a motion or presence detection : Monitoring process active
	ORANGE LED	See chapter 5: Troubleshooting

### 3 Installation

#### 1 Tips

Use the Remote-Control to adjust the sensor.	Use the Spotfinder to locate the safety curtains.	Avoid touching electrical parts!	Avoid touching optical parts!	Make sure the operator cover is fixed properly and electrically earthed.
Avoid vibrations!!!	Do not cover the sensor!	Avoid moving objects in proximity to the sensor!	Avoid HF lamps and fluorescent lighting in the infrared field!	Avoid highly reflective objects in the infrared field!

## 2 Mounting the sensor



Mount the sensor at a maximum height of 5cm from the bottom line of the door operator.

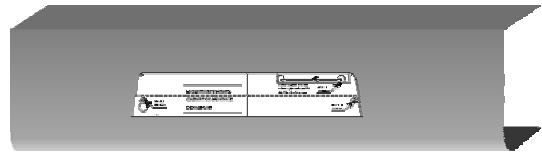

Use the mounting template to drill holes and position the sensor.

## 3 Wiring the sensor

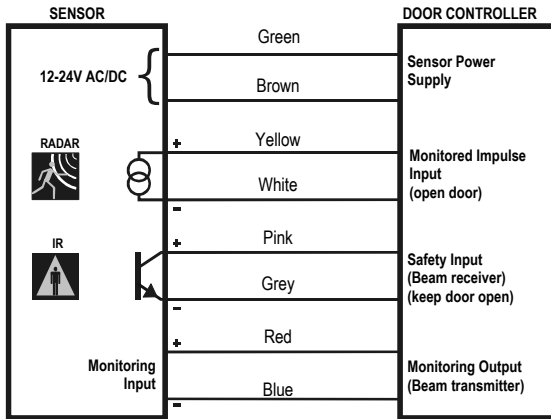

To ensure a good water protection, place the cable as shown above.

## 4 Radar motion sensing field : width

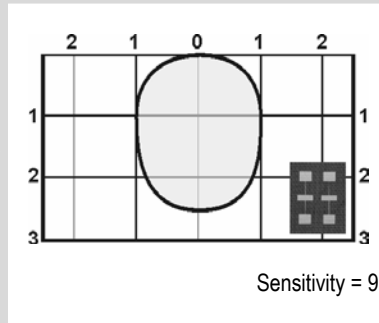
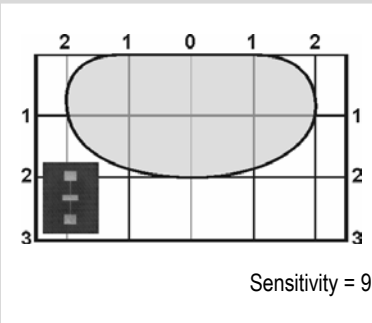

## 5 Radar motion sensing field : depth

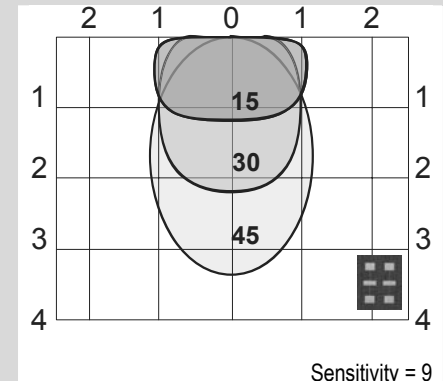
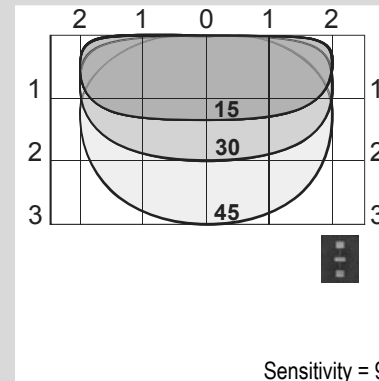
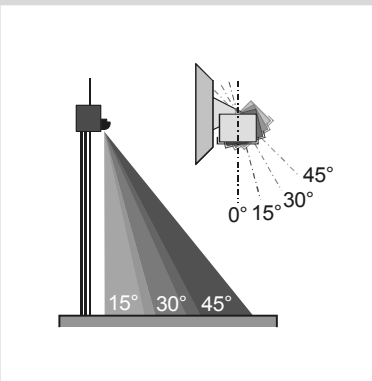

6



### IR presence sensing field : width

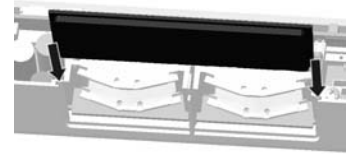
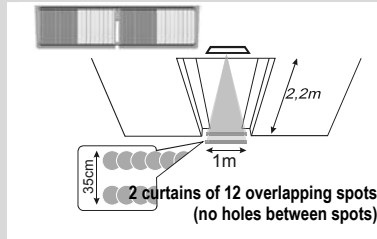
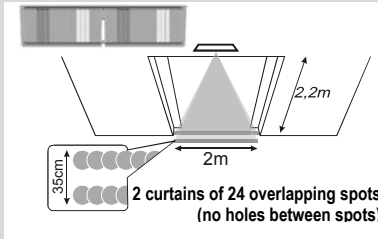

Make sure to introduce the front prism into the foreseen slides in front of the lenses!



Above 3 m mounting height, use the narrow prism!

7



### IR presence sensing field : depth (negative angle available)

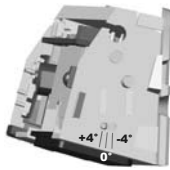
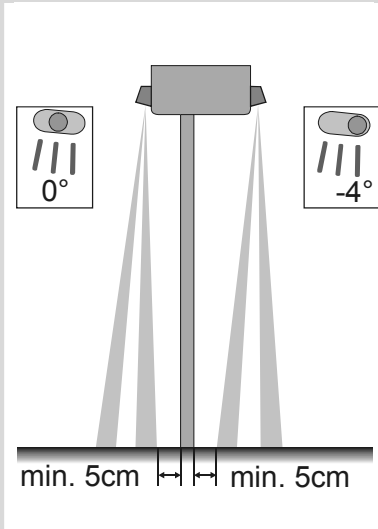

The pin shown here above indicates the angle adjusted.



To approach the curtain to the door, turn the screw clockwise.  
To tilt the curtain out, turn the screw counterclockwise.

← Keep a **minimum distance of 5cm** between the door and the first curtain.

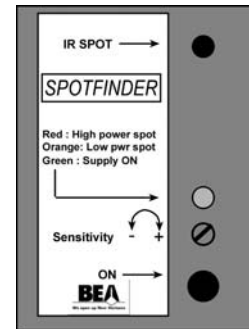

Use the Spotfinder (accessory) to locate and adjust the position of the curtains.



When mounting one sensor on each side of the door above a highly reflective threshold, select different frequencies to avoid crosstalk between the sensors (see setting "Installation configuration" on p.5).

# 8



## Remote Control adjustments (only when factory settings do not match)

<b>Unlock</b> the sensor to enter into adjustment session (if no access code has been entered)	Press Unlock key RED LED flashes slowly
To change the value of a parameter (ex. Maximum duration of presence detection)	Select parameter to change RED LED flashes quickly Enter new value RED LED flashes slowly
... to change any other parameters (ex. Output Configuration)	Select parameter to change RED LED flashes quickly Enter new value RED LED flashes slowly
To check the value of a parameter (ex. maximum duration of presence detection)	Select parameter to check RED LED flashes quickly Press Question Mark GREEN GREEN GREEN GREEN ... The number of green flashes indicate the value of this parameter RED LED flashes slowly
<b>Lock</b> the adjustment session and go back to normal function	Press Lock key twice

# 8.a



## Important Remote Control adjustments

**Unlock**

**Check values**

**Lock**

**Number of IR curtains**

1 1 curtain (safety curtain close to the door)

2♦ 2 curtains

3 2nd curtain in dynamic mode

**Sensitivity**

0 (min) → 9 (max)  
Factory value : 7

2	1	0	1	2
1		3		1
		6		
2		9		2
3				3

**IR curtain immunity**

1♦ **normal**

2 increased

3 rain-mode

4 snow-mode

5 snow-mode enhanced

**Output configuration**

	Motion-Out	Presence-Out
1♦	Active	Passive
2	Passive	Active
3	Passive	Passive
4	Active	Active

**Max. duration of presence detection**

0 30 seconds

1♦ 1 minute

2 2 minutes

3 5 minutes

4 10 minutes

5 20 minutes

6 60 minutes

**Setup**

launch a setup

launch an assisted setup

restore factory settings

## 8.b



### Launch a setup (to take a reference picture)

Unlock the sensor to enter into adjustment session



To launch an assisted setup  
 → recommended after mechanical adjustments of the IR sensor module.  
 → recommended once after the first installation



The sensor performs a door opening and closing cycle to check the influence of the door leaves to the safety curtains.  
 See Troubleshooting if RED LED flashes quickly after setup.

To launch a setup  
 → recommended after change of parameters by remote control



The sensor only takes a new reference picture.

#### LED display during sensor assisted setup



Setup-process active: the sensor learns its environment.  
 After finishing the setup process, the sensor shows the following behavior:

RED LED flashing quickly The sensor 'sees' the door movement and can not finish its setup.

RED LED continuously on The sensor signals a faulty IR monitoring.

ORANGE LED continuously on The sensor encounters a signal saturation (ex. due to a highly reflective floor).

No LED turns on The sensor successfully finished its setup.

## 8.c



### Additional Remote Control adjustments

#### Safety output redirection **F1**

- 0 ♦ no redirection
- 1 transfer presence detection to motion output
- 2 motion output activated if motion and presence detection

#### Hold time

0 ♦ (0.5s) → 9 (9s)

#### Detection mode

- 1 bidirectional mode
- 2 ♦ unidirectional mode
- 3 unidirectional mode with MTF

#### Immunity

- 1 sismo
- 2 ♦ normal
- 3 Increased

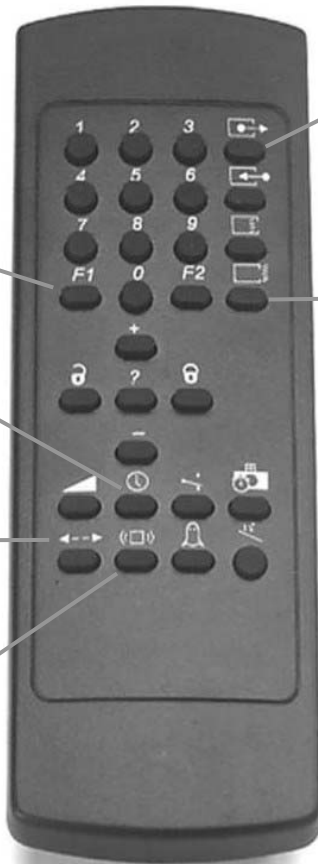











































#### External Monitoring Enable

- 0 monitoring disabled (OFF)
- 1 ♦ monitoring enabled (ON)

#### Installation Configuration

	Mounting Height	Pulse Frequency
1 ♦	Low	Low
2	High	Low
3	Low	High
4	High	High

## 4 Installation Tips

<b>TÜV Requirements in Germany</b>	<p>To be TÜV compliant for the German market, please make sure to adjust the sensor as follows:</p> <table border="0"> <tr> <td></td> <td>Number of IR curtains</td> <td>2</td> </tr> <tr> <td></td> <td>Max. duration of presence detection</td> <td>1 or higher (min. 1minute)</td> </tr> <tr> <td></td> <td>External Monitoring Enabled</td> <td>1 (ON)</td> </tr> <tr> <td></td> <td>Sensitivity (size of detection field)</td> <td>Min. 1.5m depth</td> </tr> <tr> <td></td> <td>IR curtain immunity</td> <td>1 to 3</td> </tr> </table>		Number of IR curtains	2		Max. duration of presence detection	1 or higher (min. 1minute)		External Monitoring Enabled	1 (ON)		Sensitivity (size of detection field)	Min. 1.5m depth		IR curtain immunity	1 to 3
	Number of IR curtains	2														
	Max. duration of presence detection	1 or higher (min. 1minute)														
	External Monitoring Enabled	1 (ON)														
	Sensitivity (size of detection field)	Min. 1.5m depth														
	IR curtain immunity	1 to 3														
<b>High mounting height (&gt;3m)</b>	<p>If the sensor is installed higher than 3m above the floor, make sure to use the narrow prism (see chapter "3 Installation" § 6). Also, set the sensor to "High Mounting":</p> <table border="0"> <tr> <td></td> <td>2</td> <td></td> </tr> <tr> <td>or</td> <td>Installation Configuration</td> <td>High Mounting Height</td> </tr> <tr> <td></td> <td>4</td> <td></td> </tr> </table>		2		or	Installation Configuration	High Mounting Height		4							
	2															
or	Installation Configuration	High Mounting Height														
	4															
<b>Rain/Snow</b>	<p>If the sensor is exposed to rain or snow, use the URC (Universal Rain protection Cover)</p> <p>Set the sensor to presetting 3 or 4 to increase the immunity of the sensor. You can reduce the influence of rain and snow even more when selecting the RAIN or SNOW mode for the IR curtain immunity:</p> <table border="0"> <tr> <td></td> <td>3</td> <td>RAIN mode</td> </tr> <tr> <td></td> <td>4</td> <td>SNOW mode</td> </tr> <tr> <td></td> <td>5</td> <td>SNOW mode enhanced</td> </tr> </table>		3	RAIN mode		4	SNOW mode		5	SNOW mode enhanced						
	3	RAIN mode														
	4	SNOW mode														
	5	SNOW mode enhanced														
<b>Setup</b>	<table border="0"> <tr> <td></td> <td>0</td> <td>Assisted Setup (~14sec)</td> <td>Sensor checks the influence of the door leaves to the IR curtains (performs a door open/door close cycle)</td> </tr> <tr> <td></td> <td></td> <td>Standard Setup (~4sec)</td> <td>Sensor only learns its environment</td> </tr> </table> <p>After adjusting the sensor for the first time, it is recommended to launch an "Assisted Setup". Refer to chapter "3 Installation" § 8.2 for more information about the LED display)</p> <p>If the IR sensor module "sees" the door movement, move the curtains out of the door leaves.</p>		0	Assisted Setup (~14sec)	Sensor checks the influence of the door leaves to the IR curtains (performs a door open/door close cycle)			Standard Setup (~4sec)	Sensor only learns its environment							
	0	Assisted Setup (~14sec)	Sensor checks the influence of the door leaves to the IR curtains (performs a door open/door close cycle)													
		Standard Setup (~4sec)	Sensor only learns its environment													
<b>Access Code</b>	<p>The access code is recommended to set sensors close to each other with remote control. The access code can be composed of 1 to 4 digits (factory values or no access code : 0 or 0000). No code is required to unlock during the first minute after powering.</p>															
<b>Overlapping IR-curtains</b>	<p>Overlapping IR-curtains from sensors installed side-by-side may cause disturbances due to crosstalk (interferences). Select different frequencies on each sensor to avoid crosstalk (see setting "Installation configuration" on p.5). Attention: avoid curtains that are overlapping by more than 30cm (at 2,2m mounting height, using the wide prism).</p>															
<b>No monitoring on IR curtain</b>	<p>If no monitoring of the IR sensor module is required, but the product you use has the monitoring enabled by default, set the "Monitoring" parameter to "0":</p> <table border="0"> <tr> <td></td> <td>0</td> <td>External Monitoring Enabled</td> <td>0 (= OFF)</td> </tr> </table>		0	External Monitoring Enabled	0 (= OFF)											
	0	External Monitoring Enabled	0 (= OFF)													
<b>Only one single Impulse input on door controller</b>	<p>If your door controller has only one single impulse input for motion impulse (open the door) and no safety input (keep the door open), use the "Safety Output Redirection" to transfer the safety detection (IR sensor module) to the motion impulse output and connect only the motion output to your door controller:</p> <table border="0"> <tr> <td></td> <td>F1 1</td> <td>Safety Output Redirection</td> <td>1 (= transfer presence detection to the motion output)</td> </tr> </table>		F1 1	Safety Output Redirection	1 (= transfer presence detection to the motion output)											
	F1 1	Safety Output Redirection	1 (= transfer presence detection to the motion output)													
<b>PULSE monitoring of safety sensor (beams)</b>	<p>If your door controller monitors its safety sensors using PULSE (ex. RECORD, ATS, DORMA ES-90 EM2/EM3), make sure you have a PULSE compatible product (ACTIV8 THREE PULSE).</p>															
<b>Check the wiring</b>	<p>Push the left push button to release the outputs. The door should close and the LED should switch off.</p>															

## 5 Troubleshooting

SYMPTOMS	POSSIBLE CAUSES	CORRECTIVE ACTION
Red LED flashing quickly after an assisted setup.	The sensor 'sees' the door movement and can not finish its setup.	Adjust the position of the IR curtains.
Orange LED permanently ON after an assisted setup.	The sensor encounters a signal saturation.	Use the wide-field prism and/or slightly increase the IR curtains angle (turning the screw counterclockwise).
Red LED permanently ON after an assisted setup.	The sensor fails the IR test.	Cut and restore the power supply. Launch a new assisted setup. If the LED still stays ON, replace the sensor.
Orange LED ON	The sensor encounters a signal saturation.	Use the wide-field prism and/or slightly increase the IR curtains angle (turning the screw counterclockwise). Launch an assisted setup.
Orange LED flashes	The sensor signals an internal fault.	Cut and restore the power supply. If the orange LED lights up again, replace faulty sensor.
Red LED ON	The sensor detects a presence.	Wait the time set in "maximum duration of presence detection" setting or launch an assisted setup (with the remote control or right push button).
Unwanted presence detection	The sensor is not placed properly and/or the front face is not properly fixed.	Fasten the sensor firmly and/or check whether the front face prism is placed into the foreseen slides (see section 6) and not in the sensor cover.
Door keeps recycling open-closed.	The sensor is disturbed by the door motion because it sees the door or because of vibrations.	Green LED signals a motion detection : increase the radar angle Red LED signals infrared detection : increase the IR curtains angle (turning the screw counterclockwise).
The door is not closing. LED OFF	On-Off switch at door control is in wrong position or is faulty.  Improper output configuration on the sensor.  Faulty sensor monitoring of the door controller.	Check to insure that On-Off switch for door is in the ON or AUTOMATIC position.  Check the output configuration setting on each sensor.  Check if the monitoring mode is ON or PULSE depending on the door controller. Check the wiring.
After a power on, there is no LED-signal, even during a motion detection. The motion output is active and the presence output is fixed.	The sensor's monitoring input is not correctly supplied.	Check the wiring and the power supply (voltage and polarity) of the monitoring input.
		Disable the monitoring of the sensor if the door operator cannot monitor the sensor.
The door closes slowly. LED OFF	Faulty sensor monitoring of the door controller.	Check if the monitoring mode is ON or PULSE depending on the door controller. Check the wiring.
The presence detection is disturbed by the rain (red LED)		Increase the immunity of the curtains (immunity 3 up to 5)
The radar detection is disturbed by the rain (green LED).		Check whether the unidirectional mode is selected and the MTF function is disabled. Increase the radar immunity.
The sensor does not unlock when access code is entered.	Improper code being entered.	Cut and restore power supply. No code is required to unlock during the first minute after powering. Press on "unlock", then on "lock" and introduce a new access code.
The sensor does not respond to the remote control.	1. Batteries in the remote control are dead or not installed properly. 2. Remote control badly pointed.	1. Check to insure that the batteries are installed correctly or replace batteries. 2. Point the remote control towards the sensor.

## 6 Technical Specifications



Supply voltage	: 12V (- 5%) to 24V (+10%) AC/DC
Mains frequency	: 50 - 60 Hz
Power consumption	: < 3 W
Mounting height	: 1.8m to 4m
Sensitivity of the monitoring input	: 10-30V DC
Delay of the output activation after stimulation	: < 1ms
3-color LED	: RED (presence detection) – GREEN (motion detection) – ORANGE (signal saturation, error)
Temperature range	: -25°C to +55°C
Degree of protection	: IP54
Norm conformity	: R&TTE 1999/5/EC; EMC 89/336/EEC; TÜV; BS
Dimensions	: 262 mm (L) x 55 mm (H) x 44 mm (D)
Weight	: 250 g
Housing material	: ABS + LURAN S
Minimum length of cable	: ± 2.6 m
Range of Remote Control	: 5m

	MOTION SENSOR	PRESENCE SENSOR																		
<b>Detection mode</b>	Motion Minimum detection speed: 5 cm/s (measured in sensor axis)	Presence Response time: < 128ms																		
<b>Technology</b>	Microwave and microprocessor Transmitter frequency: 24.175 GHz Transmitter radiated power: < 20 dBm EIRP Transmitter power density: < 5 mW/cm <sup>2</sup>	Focused active infrared and self-monitored microprocessor Spot diameter (standard): 0.1m max Number of spots: 24 or 12 spots by curtain Number of curtains: 2																		
<b>Detection field</b>	<table border="1"> <thead> <tr> <th></th> <th>Width</th> <th>Depth</th> </tr> </thead> <tbody> <tr> <td>Wide</td> <td>4 m</td> <td>2 m</td> </tr> <tr> <td>Narrow</td> <td>2 m</td> <td>2,5 m</td> </tr> </tbody> </table>		Width	Depth	Wide	4 m	2 m	Narrow	2 m	2,5 m	<table border="1"> <thead> <tr> <th></th> <th>Width</th> <th>Depth</th> </tr> </thead> <tbody> <tr> <td>Wide</td> <td>2 m</td> <td>0,35 m</td> </tr> <tr> <td>Narrow</td> <td>1 m</td> <td>0,35 m</td> </tr> </tbody> </table>		Width	Depth	Wide	2 m	0,35 m	Narrow	1 m	0,35 m
	Width	Depth																		
Wide	4 m	2 m																		
Narrow	2 m	2,5 m																		
	Width	Depth																		
Wide	2 m	0,35 m																		
Narrow	1 m	0,35 m																		
<b>Angle</b>	From 15° to 50° in elevation (adjustable)	From - 4° to + 4° (adjustable)																		
<b>Output specification</b>	Free of potential current source State "No detection": current source ON Max. open circuit voltage: 6.5V Output voltage available at 10mA: 3V min. Typical load: up to 3 optocouplers in series State "Detection": current source OFF Leakage current: <100µA Open-circuit remained voltage: <500mV	Transistor (optocoupled transistor) Max. output current: 100 mA Max. switching power: 42 V DC																		
<b>Output holdtime</b>	0.5s to 9s (adjustable)	0,1/1s (fixed)																		

Sensing field dimensions given at 2.2m mounting height.  
Specifications are subject to changes without prior notice.

## 7 Accessories (sold individually)

